

**Installation and Operating Manual
QUADRATIC INTEGRA 2000**



Overview

The Crompton INTEGRA 2000 is a panel mounted instrument for the communication and display of electrical parameters. It combines High Accuracy measurement technology with the ease of use of a menu driven graphical display.

Measures, displays and communicates all these parameters and more: V, A, Hz, W, VA, VAr, PF, KWhr, KVA, min/max etc.

Benefits of the INTEGRA 2000:

- True RMS measurement for accurate measurement of distorted waveforms.
- Excellent harmonic handling for true power measurement.
- Standard electrical connection to 3Ø Systems.
- High accuracies maintained over a wide measuring range.
- 96x96mm DIN one piece self-contained package.
- IP54 front of panel.
- Heavy screw clamp terminals for current and voltage inputs ensure easy installation of cable up to 3mm² x 2.
- Clear indication via LCD Graphic Display Module.
- LED Back lighting for viewing in low ambient light.
- Large characters in standard fonts for easy viewing.
- Tactile feedback keypad for positive user interface.
- User friendly Interface via on screen prompts.
- The user is taken through the menu structure with ease and simplicity.
- Analogue outputs.
- RS485 serial communication output via two part, screw clamp connector.
- Uses industry standard "Modbus" Network Protocol.
- Metasys compatible for Johnson Controls N2 Bus - building management system.
- Compatible with all leading BMS systems.
- Pulsed output for Hours related functions via relay with volt free contacts.
- Designed to meet world-wide Industry standard approvals. (Safety, Performance, EMC, etc.)

Contents	Page
Overview	1
Installation	
General	3
EMC installation requirements	4
Case dimensions and panel cutout	4
Connection diagrams	5
Operating instructions	
The INTEGRA 2000 screen	6
Customisation	10
Passcode	10
Changing the passcode	11
Resetting stored values	12
Setting up the INTEGRA 2000 display	13
System settings	14
Demand period	16
Outputs	
Setting up the INTEGRA 2000 RS485 output	17
Analogue outputs	18
Pulsed outputs	20
Setting up the INTEGRA 2000 user screen	23
Options	
Option 1 - RS485 digital outputs	25
Option 2 - RS485 implementation for Johnson Controls Metasys	30
Option 3 - Analogue outputs	32
Option 4 - Pulsed outputs	32
Output connection details	33
Appendix A	
Maximum demand calculation	34
Neutral Current Calculation	34
Appendix B	
Product Specification	35

Installation

General

The INTEGRA 2000 may be mounted in a panel of any thickness up to a maximum of 5mm. Mounting is by two corner clamps and thumb screws. Consideration should be given to the space required behind the unit to allow for bends in the connection cables.

As the enclosure conforms to IP54 it is protected against ingress from water spray from all directions, additional protection to the panel may be obtained by the use of an optional gasket. The terminals at the rear of the case should be protected from liquids.

INTEGRA 2000 should be mounted in a reasonably stable ambient temperature and in any event where the operating temperature is within the range 0-50°C.

INTEGRA 2000 should not be mounted where it will be subjected to excessive direct sunlight. Vibration should be kept to a minimum.

For optimum viewing INTEGRA 2000 should be mounted so that the operator views the display as shown below.

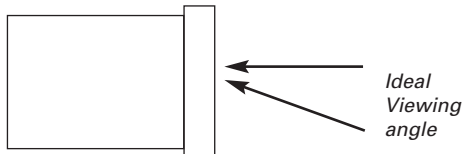

Side labels show full connection information and data. It is good EMC practice to suppress differential surges (caused by contactors, tap changes, sensitive switching, etc.) to 2.2kV at the source.

Caution

1. In the interest of safety and functionality this product must be installed by a qualified engineer.
2. Under normal or single fault conditions voltages dangerous to human life may be present at some of the terminal connections of this unit. Ensure that all supplies are de-energised before attempting any connection or disconnection.
3. These products do not have internal fuses therefore external fuses must be used for protection for safety under fault conditions.
4. The current inputs of these products are designed for connection into systems via current transformers only.

EMC Installation Requirements

This product range has been designed to meet the certification of the EU Directives when installed to a good code of practice for EMC in industrial environments. e.g.

1. Screen output and low signal input leads. Other connecting leads must be screened or have provision for fitting RF suppression components, such as ferrite absorbers, line filters etc., if RF fields cause problems. N.B It is good practice to install sensitive electronic instruments, that are performing critical functions, in EMC enclosures that protect against electrical interference causing a disturbance in function.
2. Avoid routing leads alongside cables and products that are, or could be, a source of interference.
3. To protect the product against permanent damage, surge transients must be limited to 2.2kV pk. The unit has been designed to automatically recover in the event of a high level of transients. In extreme circumstances the auxiliary supply may have to be momentarily disconnected to restore correct operation.
4. ESD precautions must be taken at all times when handling this product.

For assistance on protection requirements, please contact your local sales office.

Case Dimension and Panel Cutout

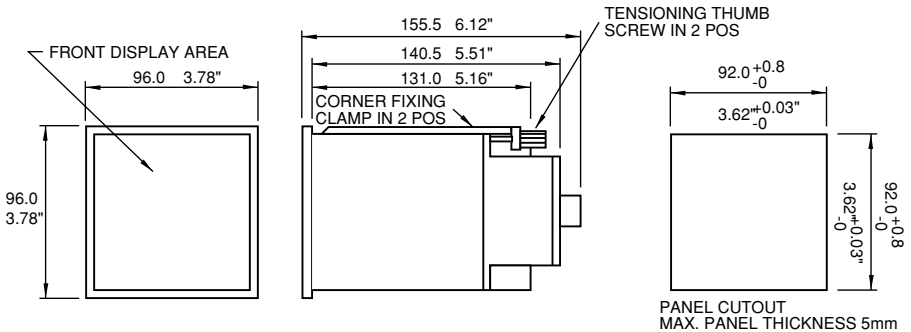

Connection Diagrams

Connection Detail

3 Ø 3 W Unbalanced load (2 element)

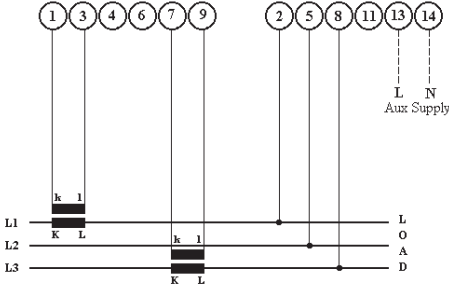

3 Ø 4W Unbalanced load (3 element)

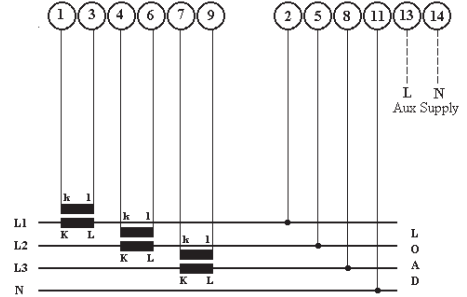

Wiring - Input connections are made directly to shrouded screw clamp terminal. Numbering is clearly marked on the plastic moulding. Choice of cable should meet local regulations. Terminals for both current and voltage inputs will accept up to 3mm² x 2 diameter cables.

Auxiliary Supply - INTEGRA 2000 ideally should be powered by a dedicated supply, however it may be powered by the signal source, providing the source remains within $\pm 10\%$ of the chosen auxiliary voltage.

Fusing - It is recommended that all voltage lines are fitted with 1 amp HRC fuses.

Earth/Ground Connections - For safety reasons, CT secondary connections should be grounded according to local codes of practice.

Import/Export Connections - The connections shown assume an import power configuration and therefore power factor is shown as import (IMP). Current will flow towards the load, if current flows away from the load, in an export power situation, then the power factor indication will change to export (EXP). This negates the need for separate export connections, because Integra serves the full four conditions of power factor.

Operating Instructions

Power measurement made easy with INTEGRA 2000

On power up and in normal operation the INTEGRA 2000 displays the initial screen. This screen is factory set to display “Volts”, “Amps”, “Frequency” and “Watt”. It may be changed to display any four parameters. See the customisation section later in this guide.

The INTEGRA 2000 screen

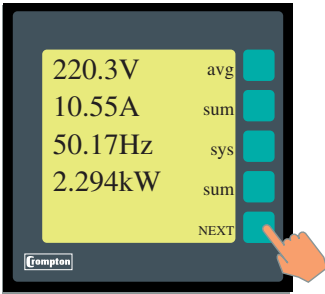

The standard viewing screen has four active readings indicated.

By **character size** and one key soft prompt.

- 1st size** Largest characters - the active readings. Four digits with dynamic scaling.
- 2nd size** The parameters for active readings with dynamic scaling to reflect Kilo, Mega etc.
- 3rd size** Indicate the relationship of the active reading to the measured system, e.g. L-L, sum etc.
- 4th size** Smallest characters - offers the key legends which guide the user through the menus of the instrument.

“Next” is the only available key function on this screen.

Press the “NEXT” key.

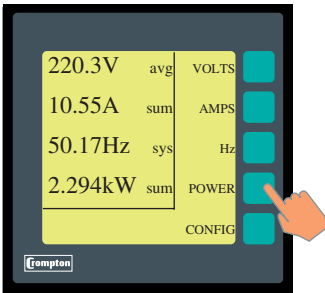

The default screen now reduces in size to reveal the first level of key legends, all readings are still active.

Each key now takes the user down to a new level of the menu structure.

This can be demonstrated by pressing “Power”

Press “POWER”

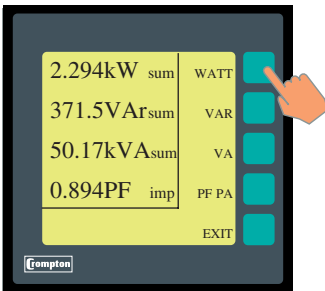

The first level power screen by default shows active readings of W, VAR, VA and PF PA.

(From this level down exiting all screens is easily done by a single keystroke “Exit”.)

Next example press the “WATT” button.

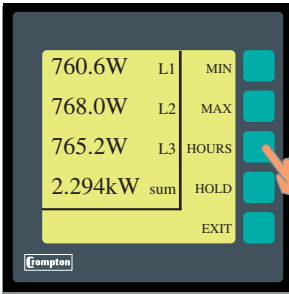

This screen now displays active reading of Watt by Line and Sum

The soft prompts keys now available are "MIN", "MAX", "HOURS" and "HOLD".

Press "HOURS"

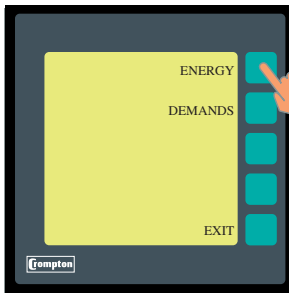

Press "ENERGY"

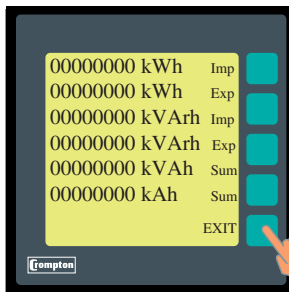

This screen displays all Hour related functions, both import and export where appropriate.

Press "EXIT" and this will revert to the previous screen.

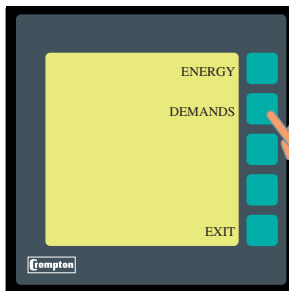

Press "DEMANDS"

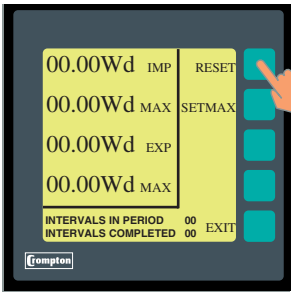

Press **"SETMAX"** to return the maximum demand to the present demand value.

Press **"RESET"** to begin or re-start the demand period

Press **"EXIT"** twice

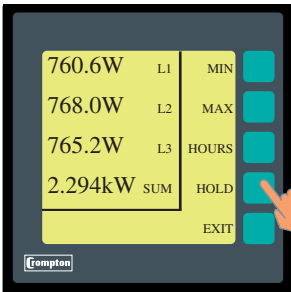

Press **"HOLD"**

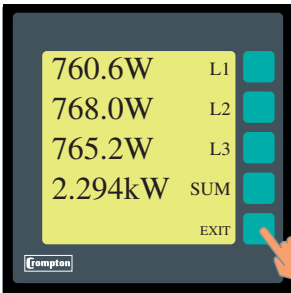

This will expand the active screen to full size. This screen remains until deactivated by pressing **"EXIT"** where it will return to the reduced active screen.

Press **"EXIT"**

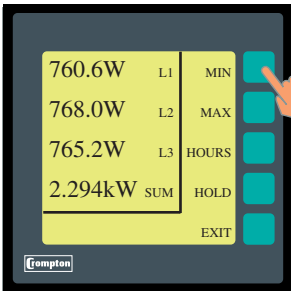

The minimum and maximum values are stored for each reading.

The minimum and maximum values can be reset at the customisation screen.

Press **"MIN"**

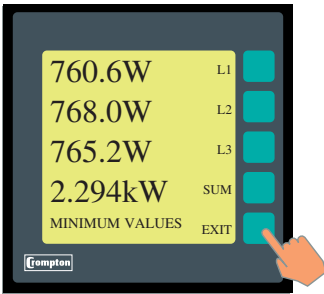

The minimum values are shown.

Press "EXIT"

Press "MAX" shows the maximum values.

Press "EXIT"

Press "EXIT" again

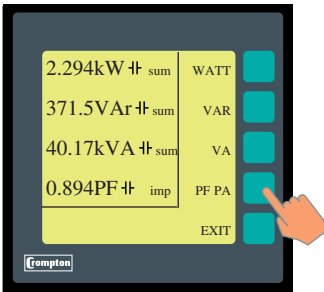

All the screen stages for "WATT" are repeated for "VAR" and "VA".

Press "PF PA"

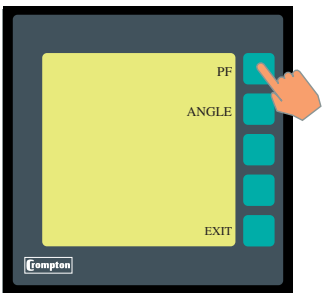

On pressing "PF PA" the display offers two choices for displaying the phase relationships: Power Factor ("PF") and Phase Angle ("ANGLE").

Either choice will give the same information, displayed in the chosen way.

Press "PF"

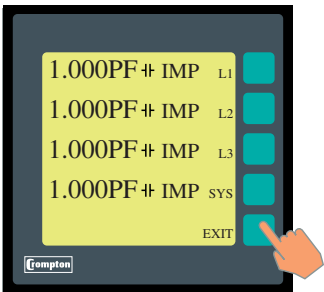

The power factor for each phase, and the sum, is displayed.

Two pieces of information are shown to indicate the Quadrant in which the load is operating:

A symbol is used to indicate a Capacitive (\pm) or Inductive (L) load. The direction is shown as "IMP" for Importing and "EXP" Exporting.

The only soft prompt available is "EXIT" which will take you to the previous screen.

The "EXIT" button is pressed as many times as necessary to return to the first menu screen. Note that if a key is not pressed for approximately one minute the display will automatically revert to the initial screen. This will not occur if a screen has been held by using the "HOLD" button.

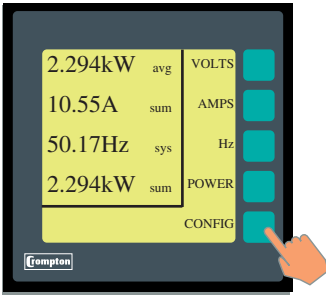

Customisation

Press **"NEXT"**

Press **"CONFIG"**

This enters into the customising area of the menu structure. All critical functions request confirmation. Pressing **"EXIT"** again allows easy escape without change.

The unit will revert to the initial screen approximately one minute after the last keypress. This means it cannot be left in a configuration menu. Any partially completed changes will be discarded.

There are four main options:

"SYSTEM" Gives status information for field service personnel.

"PASSCODE" Allows the user to change the protection passcode

"RESET" Allows the user to clear the hours related counters, the Minimum and Maximum values and the Demand values.

"SETUP" Allows the user to customise the Scaling, Demand period and Output options if fitted.

Press **"SYSTEM"**

The **"SYSTEM"** screen provides the following information:

- Firmware version.
- Communications speed, number of data bits, number of stop bits, parity and address.
- Protocol installed
- Electrical system configuration.

Press **"EXIT"**

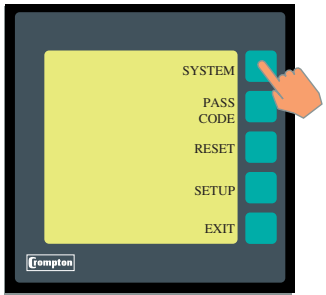

Passcode

Press **"PASSCODE"**

All settings that alter the operation of the unit are passcode protected. The user must enter the correct code before access to the configuration menu is allowed.

NOTE: The factory default setting is "0000"

Once this passcode has been entered, it remains valid for all menus. If the keys are not pressed for a one minute period the unit exits the configuration menu and returns to the default screen. The passcode will have to be re-entered for any further configuration.

The passcode is a number between 0000 and 9999. It can be changed by the user to any number. The factory default is 0000.

Pressing **"OK"** with the factory default password will allow access to the customisation.

NOTE: To secure system settings, countries and configuration a password should always be used.

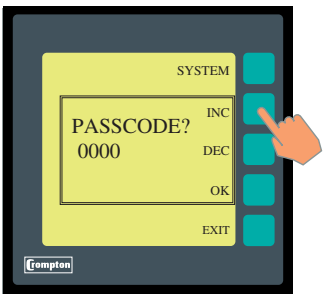
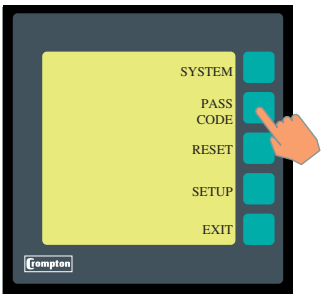

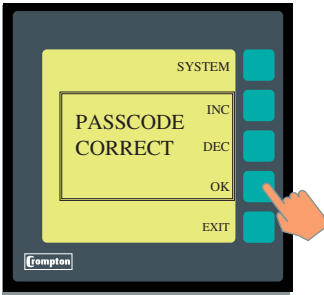

To select the passcode, the “INC” and “DEC” keys are used to increment and decrement the displayed number. Pressing the “DEC” key with 0000 displayed will change the number to 9999.

The number will automatically increment and decrement if the “INC” or “DEC” key is held depressed. The longer the key is held, the faster the numbers will change.

Once the correct number is displayed, press the “OK” button.

If the displayed passcode matches the correct value, the screen will show “PASSCODE CORRECT” and return to the previous screen.

Changing the Passcode

NOTE: If the current passcode has not been entered during this configuration session the user will be prompted to enter it at this stage.

Press “EXIT”

Press “PASSCODE”

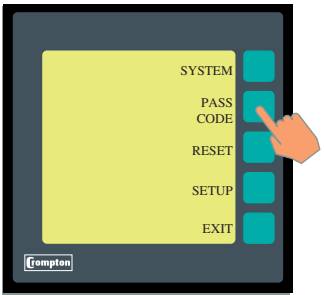

To select the new passcode, the “INC” and “DEC” keys are used to increment and decrement the displayed number. Pressing the “DEC” key with 0000 displayed will change the number to 9999.

The number will automatically increment and decrement if the “INC” or “DEC” key is held depressed. The longer the key is held, the faster the numbers will change.

Once the desired number is displayed, press the “OK” button.

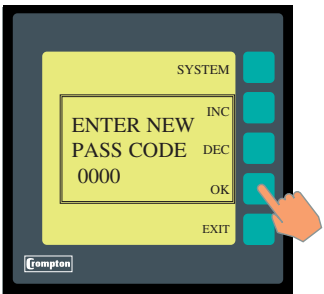

The screen will return to the previous menu

NOTE : If the password is changed and subsequently forgotten, please contact your nearest sales and service centre for assistance. A list of telephone numbers and addresses is printed on the rear cover of this manual.

Press “RESET”

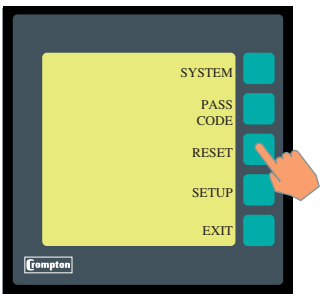

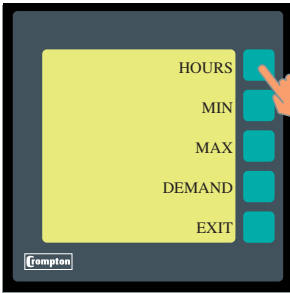

Resetting Stored Values

This menu allows the user to reset any of the stored values. These include all the hours related parameters (W.h, VAR.h, VA.h, A.h), the Minimum values, the Maximum values and the Demand values.

Press **"HOURS"**

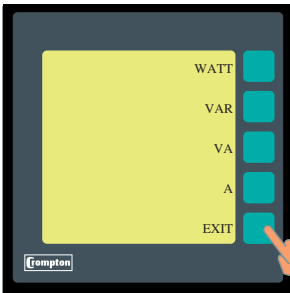

Press **"WATT"** to zero accumulated W.h. **"RESET"** will appear to the left indicating this choice has been made. A similar function is performed by the **"VAR"**, **"VA"** and **"A"** keys.

Press **"EXIT"**

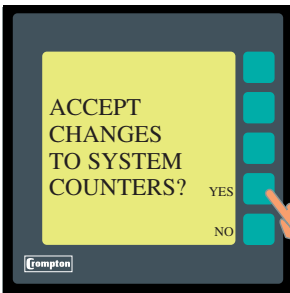

The screen now asks the operator to confirm changes.

"YES" will implement the changes and take the user back to the reset screen.

"NO" will not implement the changes, but will also take the user back to the reset screen.

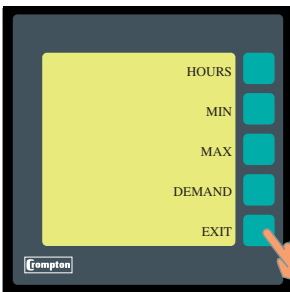

The **"MIN"**, **"MAX"** and **"DEMAND"** keys perform a similar function to the stored minimum, maximum and demand values.

Press **"EXIT"**

Setting up the INTEGRA 2000 display

Press "SETUP"

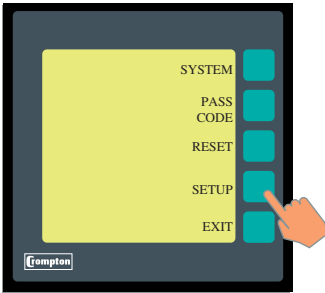

This screen offers four options:

"DISPLAY" allows the user to adjust the display update time.

"SYSTEM SETTINGS" allows the user to enter CT and VT ratios. The unit will then display all parameters scaled to the primary values.

"DEMAND PERIOD" allows the user to change the integration period of the Maximum Demand functions. The same interval is used for all parameters.

"OUTPUTS" allows the configuration of the optional output modules.

Press "DISPLAY"

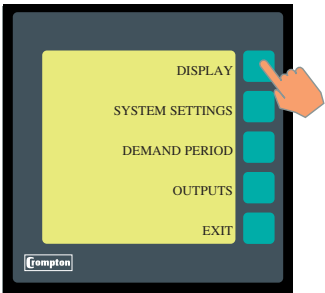

Press "UPDATE RATE". This screen allows the screen update time to be modified. The standard update time is approximately 100ms but users can programme the Integra 2000 to override up to 20 updates thereby avoiding digit roll. Analogue and digital outputs are not affected by this feature. The bar flashes at the selected rate to assist selection.

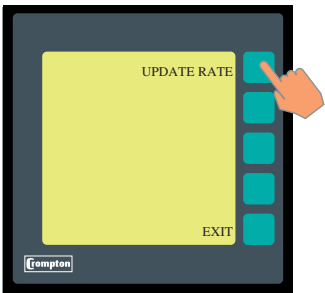

Press and hold the "MORE" or "LESS" buttons, this will increment the number on the far left of the screen.

The higher the number, ("MORE") the higher the number of updates missed.

The lower the number, ("LESS") the lower the number of updates missed.

Press "EXIT" twice to return to the set-up screen.

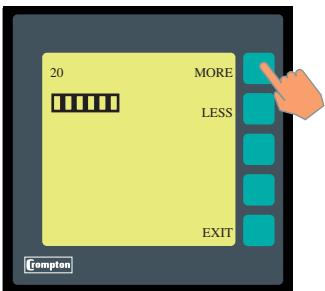

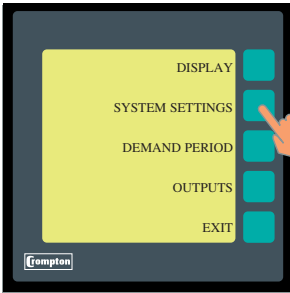

System Settings

Press **"SYSTEM SETTINGS"**

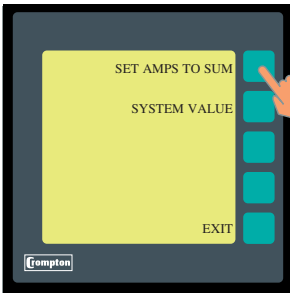

By pressing **"SET AMPS TO SUM"** you answer a question.

"SET AMPS TO SUM" or **"SET AMPS TO AVERAGE"**

This screen if the sum on the average of the three phases of current are displayed on the default screen.

Press **"SYSTEM VALUES"**

This screen is used to set up the primary system voltage and current values. The values entered here should be the primary values of the system CT's and VT's.

e.g. if a 40/5 CT is used, the current setting should read 40.

For a 4 wire system, the voltage value is the Line to Neutral (L-N) voltage.

For a 3 wire system, the voltage value is the Line to Line (L-L) voltage.

"INC" increments the selected character over its available range

e.g. numbers = 0 to 9
parameters = V, kV, etc.

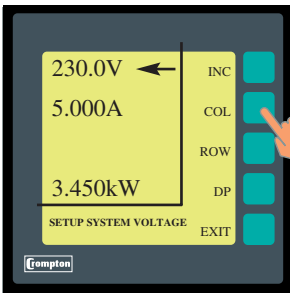

- If 6.8kV/110V VT is used, the voltage setting should read 6.800kV. The VT secondary voltage must be the same as the product voltage given on the label.

- If no VT is used, the voltage setting must be the same as the product voltage given on the label.

"COL" selects the column to be changed by the **"INC"** button. The digit to be changed goes in to inverse mode.

"DP" (Decimal Point) Selects the correct decimal point position.

Change the voltage value to match the system primary value. When this has been done, press the **"ROW"** button.

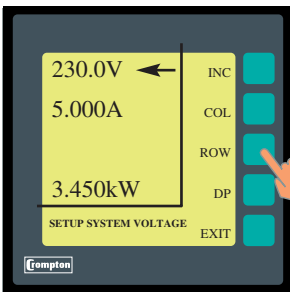

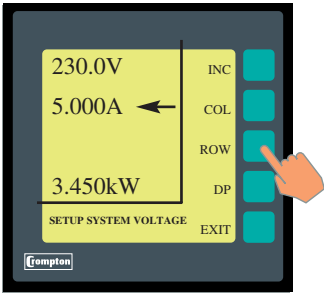

Change the current value to match the system primary value.

Note: The watt reading will update automatically.

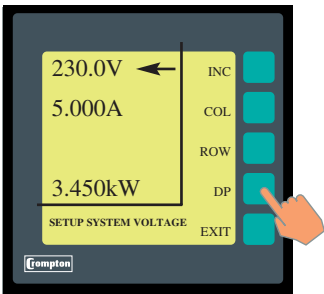

Press "EXIT"

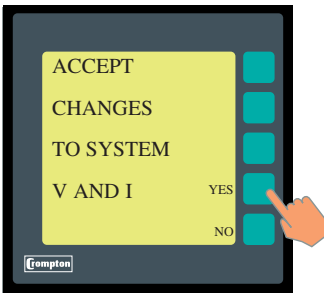

This screen now asks the operator to confirm changes.

"YES" will implement the changes and take the user back to the "SETUP" screen.

"NO" will not implement the changes but will also take the user back to the "SETUP" screen

Press "EXIT"

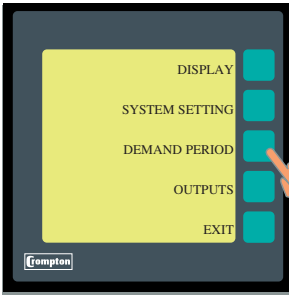

Demand Period

Press “**DEMAND PERIOD**”

This screen sets up the two parameters that define the averaging response. Refer to Appendix A for further information. This uses the same procedure as the previous set up screen.

The SUB INTERVAL LENGTH can be any value between 1 and 30 minutes. The NUMBER OF SUB INTERVALS can be any value between 1 and 30.

On completion, press “**EXIT**”

Accept or ignore changes here.

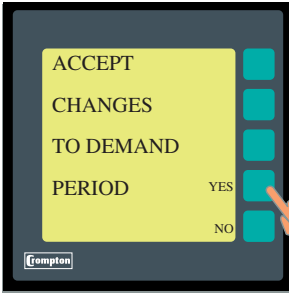

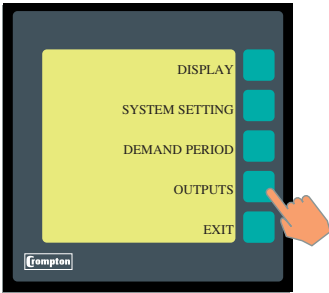

Outputs

Press "OUTPUTS"

This screen lists the available output options supported by the unit. Note that although the software can be configured, additional hardware output modules may be required. Contact your local sales and service centre for assistance.

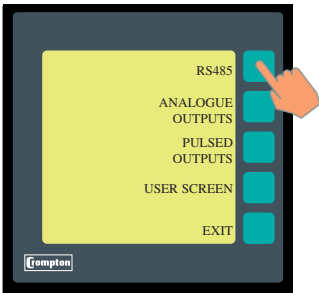

Setting up the INTEGRA 2000 RS485 output

Press "RS485"

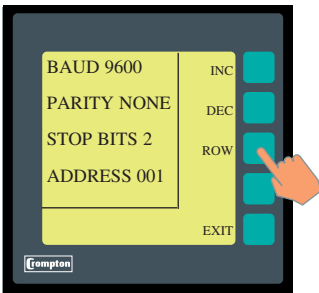

This screen allows the user to configure the parameters for the RS485 port. *NOTE: Communicatios settings for Johnsons Controls are fixed and pre set.* A pointer is shown next to the value being changed. The "INC" and "DEC" keys are used to increment and decrement the displayed value. The "ROW" key is user to move the pointer to the next parameter.

The Baud rate is selectable to 2400, 4800, 9600 and 19,200. The Parity can be set to EVEN, ODD or NONE. The Stop Bits are adjusted automatically, depending on the Parity setting.

The address can be set to any value between 001 and 247. Address 0 (Broadcast mode) is not supported.

Press "EXIT" when the values have been amended correctly

The screen now asks the operator to confirm changes.

"YES" will implement the changes

"NO" will discard the changes.

Pressing either key will take the user back to the output screen.

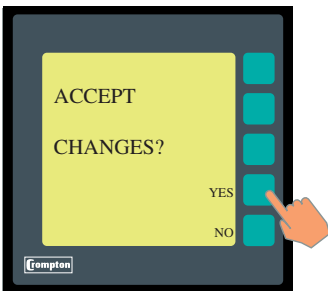

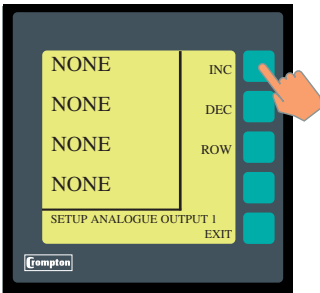
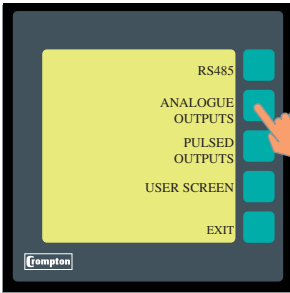

Analogue Outputs

Press “ANALOGUE OUTPUTS”

This screen assigns a parameter to each of the four analogue outputs.

“INC” cycles the selected parameter forward through the list.

“DEC” cycles the selected parameter backwards through the list.

“ROW” moves the pointer to the next output channel.

All of the keys will auto-repeat if held down.

Parameter	Description	Scaling
NONE	No assigned value	Zero
V 1	Volts 1	0-100%
V 2	Volts 2	0-100%
V 3	Volts 3	0-100%
V AVG	Volts Average	0-100%
V L1/L2	Volts L1-L2	0-100%**
V L2/L3	Volts L2-L3	0-100%**
V L3/L1	Volts L3-L1	0-100%**
V L/L AVG	Volts L-L Average	0-100%**
I 1	Current 1	0-100%
I 2	Current 2	0-100%
I 3	Current 3	0-100%
I SUM	Current Sum	0-100%
I AVG	Current Average	0-100%*
I NEUTRAL	Neutral Current	0-100%*
W 1 IMP	Watts 1 Import	0-100%*
W 2 IMP	Watts 2 Import	0-100%*
W 3 IMP	Watts 3 Import	0-100%*
W SUM IMP	Watts Sum Import	0-100%*
W 1 EXP	Watts 1 Export	0-100%*
W 2 EXP	Watts 2 Export	0-100%*
W 3 EXP	Watts 3 Export	0-100%*
W SUM EXP	Watts Sum Export	0-100%*
VAR 1 IMP	VAR 1 Import	0-100%*
VAR 2 IMP	VAR 2 Import	0-100%*
VAR 3 IMP	VAR 3 Import	0-100%*
VAR SUM IMP	VAR Sum Import	0-100%*
VAR 1 EXP	VAR 1 Export	0-100%*
VAR 2 EXP	VAR 2 Export	0-100%*
VAR 3 EXP	VAR 3 Export	0-100%*
VAR SUM EXP	VAR Sum Export	0-100%*
VA 1	VA 1	0-100%
VA 2	VA 2	0-100%
VA 3	VA 3	0-100%
VA SUM	VA Sum	0-100%
HZ	Frequency	45-65 Hz
PHANGLE 1	Phase Angle 1	+180° / 0 / -180°
PHANGLE 2	Phase Angle 2	+180° / 0 / -180°
PHANGLE 3	Phase Angle 3	+180° / 0 / -180°
ANGLE AVG	Phase Angle Average	+180° / 0 / -180°
PF 1	Power Factor 1	+180° / 0 / -180°
PF 2	Power Factor 2	+180° / 0 / -180°
PF 3	Power Factor 3	+180° / 0 / -180°
PF AVG	Power Factor AVG	+180° / 0 / -180°

* = For Watts and Vars, the output is positive for both Import and Export directions.

** = 3 phase 4 wire mode only.

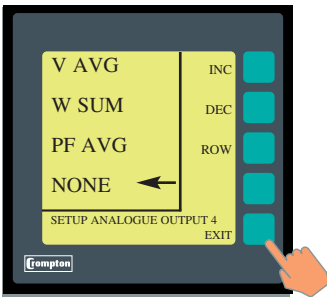

If any output is assigned to be "NONE", a zero value will be transmitted.

The same value may be assigned to more than one output if necessary.

Once all four outputs have been assigned, press "EXIT"

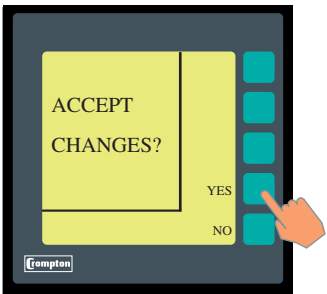

The screen now asks the operator to confirm changes.

"YES" will implement the changes

"NO" will discard the changes

Pressing either key will take the user back to the output screen.

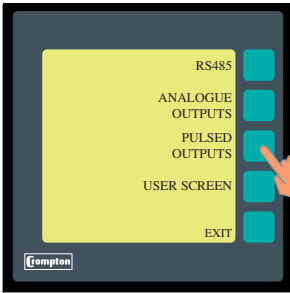

Pulsed Outputs

Press "PULSED OUTPUTS"

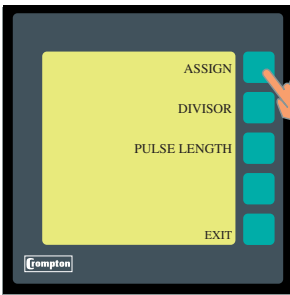

This menu has three options:

"**ASSIGN**" assigns a parameter to each output

"**DIVISOR**" enables a divide ratio of 10, 100 or 1000

"**PULSE LENGTH**" sets the duration of the pulse length from 20mS to 200mS

Press "**ASSIGN**"

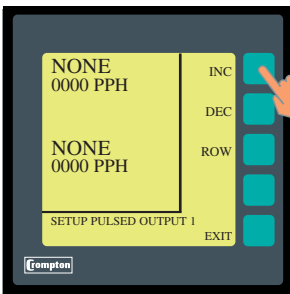

This screen assigns a parameter to each of the pulsed outputs.

"**INC**" cycles the selected parameter forward through the list.

"**DEC**" cycles the selected parameter backwards through the list.

"**ROW**" moves the pointer to the other output channel.

All of the keys will autorepeat if held down.

The line reading "**0000 PPH**" indicates how many pulses per hour will be output for that parameter at full scale power. This number is automatically determined by the unit from the VT and CT ratio settings made in the main setup menu. The number of pulses may be divided down using the "**DIVISOR**" option, described later.

NOTE: The maximum pulse rate is 3600 pulses per hour. Suitable for systems up to 3.6 MW (3,600 kW). If greater than 3.6 MW pulses autorange to 1 pulse per MW.h.

The list of parameters is as follows:

Parameter	Description
NONE	No assigned value
IMP WATT HR	Import Watt Hours
EXP WATT HR	Export Watt Hours
IMP VAR HR	Import VAR Hours
EXP VAR HR	Export VAR Hours
VA HOUR	VA Hours
AMP HOUR	Amp Hours

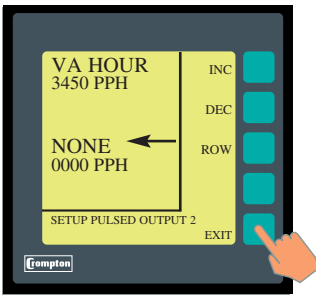

If any output is assigned to be "NONE", no pulses will be transmitted.

The same value may be assigned to more than one output if necessary.

Once both outputs have been assigned, press "EXIT"

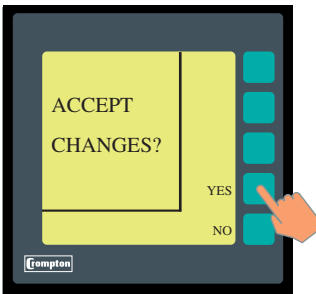

The screen now asks the operator to confirm changes.

"YES" will implement the changes

"NO" will discard the changes

Pressing either key will take the user back to the pulsed output screen.

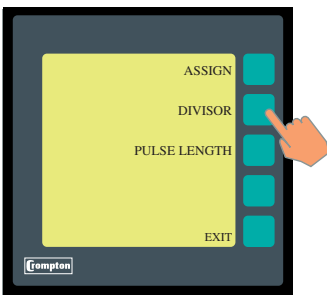

The "DIVISOR" screen enables a divide ratio of 10, 100 or 1000. This allows the user to program the unit to output a lower number of pulses according to the system requirements. For example, setting the divisor to 1000 will output kilowatt hour pulses, and setting the divisor to 1 will output Watt hour pulses.

Press "DIVISOR"

This screen assigns a divisor value to each of the pulsed outputs.

"INC" cycles the value between 1, 10, 100 and 1000.

"DEC" cycles the value backwards through the list.

"ROW" moves the pointer to the other output channel.

All of the keys will autorepeat if held down.

Note that the Pulses per hour (PPH) figure is automatically calculated to show the number of pulses that will be transmitted at full-scale power.

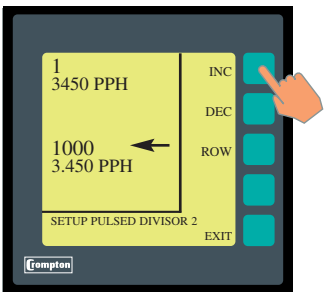

NOTE: If the system power is scaled in kW then the default pulse rate is 1 pulser per kWh (up to 3,600 kW system). If the system power (see system settings) is over 3.6 MW then the pulse rates adjust accordingly to 1 pulse per MWh.

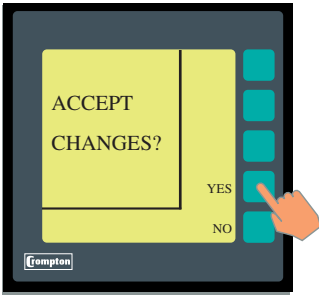

The screen now asks the operator to confirm changes.

“**YES**” will implement the changes

“**NO**” will discard the changes

Pressing either key will take the user back to the pulsed output screen.

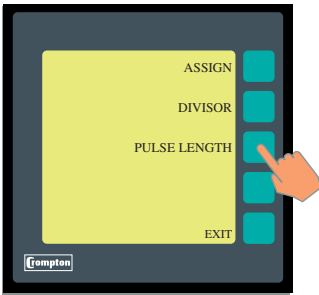

The “**PULSE LENGTH**” screen enables the width of each output pulse to be adjusted in 20mS increments between 20 and 200mS.

Press “**PULSE LENGTH**”

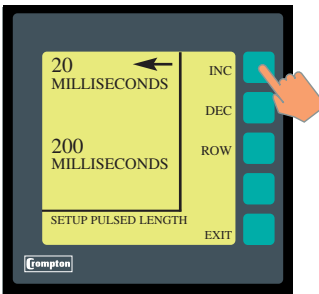

“**INC**” increases the value in 20mS increments up to a maximum of 200mS

“**DEC**” decreases the value in 20mS increments down to a minimum of 20mS

“**ROW**” moves the pointer to the other output channel.

All of the keys will autorepeat if held down.

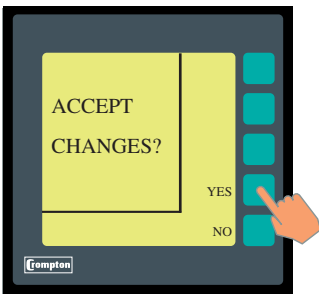

The screen now asks the operator to confirm changes.

“**YES**” will implement the changes

“**NO**” will discard the changes

Pressing either key will take the user back to the pulsed output screen.

Press “**EXIT**” again to return to the output screen

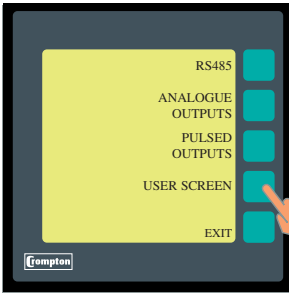

Setting up the INTEGRA 2000 user screen

The unit defaults to an initial screen after a period of one minute from the last button press. This initial screen may be changed to display particular parameters of interest. The factory default setting of Vavg, Asum, Hz and Wsum is shown if a user screen is not programmed, or if all choices are set to NONE.

Press **"USER SCREEN"**

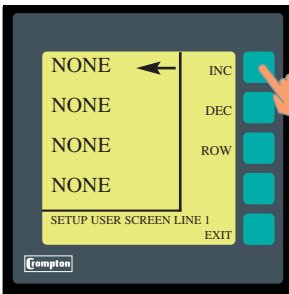

This screen assigns a parameter to each of the four screen lines.

"INC" cycles the selected parameter forward through the list.

"DEC" cycles the selected parameter backwards through the list.

"ROW" moves the pointer to the next zone.

All of the keys will autorepeat if held down.

The list of parameters is as follows:

Parameter	Description
NONE	No assigned value
V 1	Volts 1
V 2	Volts 2
V 3	Volts 3
V AVG	Volts Average
V L1/L2	Volts L1-L2*
V L2/L3	Volts L2-L3*
V L3/L1	Volts L3-L1*
V L/L AVG	Volts L-L Average*
I 1	Current 1
I 2	Current 2
I 3	Current 3
I SUM	Current Sum
I AVG	Current Average
I NEUTRAL	Neutral Current
W 1	Watts 1
W 2	Watts 2
W 3	Watts 3
W SUM	Watts Sum
VAR 1	Var 1
VAR 2	Var 2
VAR 3	Var 3
VAR SUM	Var Sum

Parameter	Description
VA 1	VA 1
VA 2	VA 2
VA 3	VA 3
VA SUM	VA Sum
HZ	Frequency
PHANGLE 1	Phase Angle 1
PHANGLE 2	Phase Angle 2
PHANGLE 3	Phase Angle 3
ANGLE AVG	Phase Angle Average
PF1	Power Factor 1
PF2	Power Factor 2
PF3	Power Factor 3
PF AVG	Power Factor Average
IMP WATT HR	Import Watt Hours
EXP WATT HR	Export Watt Hours
IMP VAR HR	Import Var Hours
EXP VAR HR	Export Var Hours
VA HOUR	VA Hours
AMP HOUR	Amp Hours

* = 3 phase 4 wire mode only

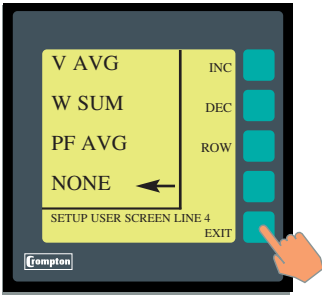

If any line is assigned to be "NONE", a blank space will be shown. If all four lines are assigned "NONE" the factory default screen of Vavg, Asum, Hz and Wsum is shown.

Once all four lines have been assigned, press "EXIT"

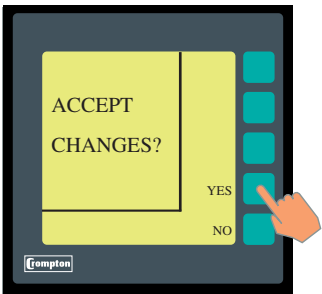

The screen now asks the operator to confirm changes.

"YES" will implement the changes

"NO" will discard the changes

Pressing either key will take the user back to the output screen.

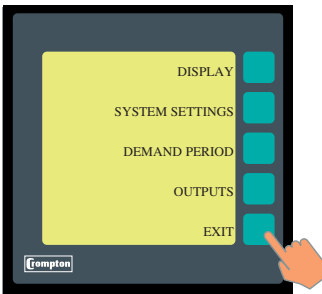

Press "EXIT" once again to return to the setup screen.

Press "EXIT" to return to the configuration screen.

Press "EXIT" to return to the measurement screen.

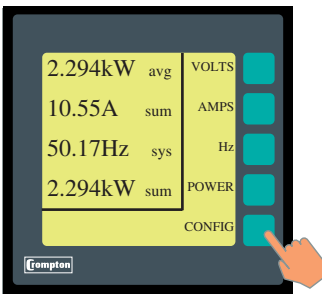

The user is returned to the first menu screen.

If no user screen has been defined the soft prompts will disappear after a short time and will return to the large character active reading screen.

If a user screen has been defined this will be shown immediately.

Normally the characters will retain their usual size, i.e. voltage being the largest size and energy the second size. However, if one of the lines selected is normally the second size then all lines will also be the second size.

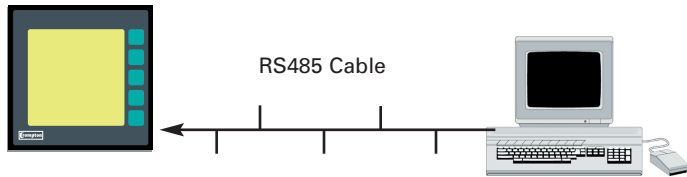

Option 1 - RS485 Digital Outputs

MODBUS® Implementation

INTEGRA 2000 offers the option of a RS485 communication module for direct connection to SCADA systems using the MODBUS® RTU protocol.

The MODBUS, protocol establishes the format for the master's query by placing into it the device address, a function code defining the requested action, any data to be sent, and an error checking field. The slave's response message is also constructed using Modbus protocol. It contains fields confirming the action taken, any data to be returned, and an error checking field. If an error occurred in receipt of the message, or if the slave is unable to perform the requested action, the slave will construct an error message and send it as its response.

The electrical interface is 2-wire RS485 (half duplex), via a 3 way 2 part connector. Connection should be made using twisted pair screened cable (Typically 22 gauge Belden 8761 or equivalent). All "A" and "B" connections are daisy chained together. The screens should also be connected to the "Gnd" terminal. To avoid the possibility of loop currents, an Earth connection should be made at one point on the network. See the connection diagram for details.

A total maximum length of 1200M is allowed for the RS485 network. A maximum of 32 electrical nodes can be connected, including the controller. The cable should be terminated with a resistor at each end.

The address of each Integra 2000 can be set to any value between 1 and 247. Broadcast mode (address 0) is not supported.

The maximum latency time of an Integra 2000 is 200mS (Average 50mS) i.e. this is the amount of time that can pass before the first response character is output. The supervisory programme must allow this period of time to elapse before assuming that the INTEGRA 2000 is not going to respond.

Modbus® Register Addresses

Parameter No	Modbus Start Address		Parameter	Integra 2000 Configuration (No of Wires)		
	High Byte	Low Byte		4	3	2
	1	00		00	Volts 1	✓
2	00	02	Volts 2	✓	✓	x
3	00	04	Volts 3	✓	✓	x
4	00	06	Current 1	✓	✓	✓
5	00	08	Current 2	✓	✓	x
6	00	0A	Current 3	✓	✓	x
7	00	0C	Watts 1	✓	x	✓
8	00	0E	Watts 2	✓	x	✓
9	00	10	Watts 3	✓	x	x
10	00	12	VA 1	✓	x	✓
11	00	14	VA 2	✓	x	x
12	00	16	VA 3	✓	x	x
13	00	18	VAr 1	✓	x	✓
14	00	1A	VAr 2	✓	x	x
15	00	1C	VAr 3	✓	x	x
16	00	1E	Power Factor 1	✓	x	✓
17	00	20	Power Factor 2	✓	x	x
18	00	22	Power Factor 3	✓	x	x
19	00	24	Phase Angle 1	✓	x	✓
20	00	26	Phase Angle 2	✓	x	x
21	00	28	Phase Angle 3	✓	x	x
22	00	2A	Volts Ave	✓	✓	✓
23	00	2C	Reserved			
24	00	2E	Current Ave	✓	✓	✓
25	00	30	Current Sum	✓	✓	✓
26	00	32	Reserved			
27	00	34	Watts Sum	✓	✓	✓
28	00	36	Reserved			
29	00	38	VA Sum	✓	✓	✓
30	00	3A	Reserved			
31	00	3C	VAr Sum	✓	✓	✓
32	00	3E	Power Factor Ave	✓	✓	✓
33	00	40	Reserved			
34	00	42	Phase Angle Ave	✓	✓	✓
35	00	44	Reserved			
36	00	46	Frequency	✓	✓	✓
37	00	48	W.hr Import	✓	✓	✓
38	00	4A	W.hr Export	✓	✓	✓
39	00	4C	VAr.h Import	✓	✓	✓
40	00	4E	VAr.h Export	✓	✓	✓
41	00	50	VA.h	✓	✓	✓
42	00	52	A.h	✓	✓	✓
43	00	54	W Demand Import	✓	✓	✓
44	00	56	W Max. Demand Import	✓	✓	✓
45	00	58	W Demand Export	✓	✓	✓
46	00	5A	W Max. Demand Export	✓	✓	✓
47	00	5C	VAr Demand Import	✓	✓	✓
48	00	5E	VAr Max Demand Import	✓	✓	✓
49	00	60	VAr Demand Export	✓	✓	✓
50	00	62	VAr Demand Export	✓	✓	✓
51	00	64	VA Demand	✓	✓	✓
52	00	66	VA Max. Demand	✓	✓	✓
53	00	68	A Demand	✓	✓	✓
54	00	6A	A Max. Demand	✓	✓	✓
55	00	6C	Volts 1 Max.	✓	✓	✓

Parameter No	Modbus Start Address		Parameter	Integra 2000 Configuration (No of Wires)		
	High Byte	Low Byte		4	3	2
	56	00		6E	Volts 1 Min.	✓
57	00	70	Volts 2 Max.	✓	✓	x
58	00	72	Volts 2 Min.	✓	✓	x
59	00	74	Volts 3 Max.	✓	✓	x
60	00	76	Volts 3 Min.	✓	✓	x
61	00	78	Current 1 Max.	✓	✓	✓
62	00	7A	Current 1 Min.	✓	✓	✓
63	00	7C	Current 2 Max.	✓	✓	x
64	00	7E	Current 2 Min.	✓	✓	x
65	00	80	Current 3 Max.	✓	✓	x
66	00	82	Current 3 Min.	✓	✓	x
67	00	84	Volts Average Max.	✓	✓	✓
68	00	86	Volts Average Min.	✓	✓	✓
69	00	88	Reserved			
70	00	8A	Volts Sum Min.	x	x	x
71	00	8C	Reserved			
72	00	8E	Reserved			
73	00	90	Current Sum Max.	✓	✓	✓
74	00	92	Current Sum Min.	✓	✓	✓
75	00	94	Watt 1 Max.	✓	x	✓
76	00	96	Watt 1 Min.	✓	x	✓
77	00	98	Watt 2 Max.	✓	x	x
78	00	9A	Watt 2 Min.	✓	x	x
79	00	9C	Watt 3 Max.	✓	x	x
80	00	9E	Watt 3 Min.	✓	x	x
81	00	A0	Watt Sum Max.	✓	✓	✓
82	00	A2	Watt Sum Min.	✓	✓	✓
83	00	A4	VAr 1 Max.	✓	x	✓
84	00	A6	VAr 1 Min.	✓	x	✓
85	00	A8	VAr 2 Max.	✓	x	x
86	00	AA	VAr 2 Min.	✓	x	x
87	00	AC	VAr 3 Max.	✓	x	x
88	00	AE	VAr 3 Min.	✓	x	x
89	00	B0	VAr Sum Max.	✓	✓	✓
90	00	B2	VAr Sum Min.	✓	✓	✓
91	00	B4	VA 1 Max.	✓	x	✓
92	00	B6	VA 1 Min.	✓	x	✓
93	00	B8	VA 2 Max.	✓	x	x
94	00	BA	VA 2 Min.	✓	x	x
95	00	BC	VA3 Max.	✓	x	x
96	00	BE	VA3 Min.	✓	x	x
97	00	C0	VA Sum Max.	✓	✓	✓
98	00	C2	VA Sum Min.	✓	✓	✓
99	00	C4	Frequency Max.	✓	✓	✓
100	00	C6	Frequency Min.	✓	✓	✓
101	00	C8	V L1-L2	✓	x	x
102	00	CA	V L2-L3	✓	x	x
103	00	CC	V L3-L1	✓	x	x
104	00	CE	V L-L Ave	✓	x	x
105	00	D0	V L1-L2 Max	✓	x	x
106	00	D2	V L1-L2 Min	✓	x	x
107	00	D4	V L2-L3 Max	✓	x	x
108	00	D6	V L2-L3 Min	✓	x	x
109	00	D8	V L3-L1 Max	✓	x	x
110	00	DA	V L3-L1 Min	✓	x	x
111	00	DC	V L-L Ave Max	✓	x	x
112	00	DE	V L-L Ave Min	✓	x	x
113	00	E0	I Neutral	✓	x	x

Appendix B: Instrument Holding Registers

In the table the "System Configuration" is defined by the number of wires, 4 represents a 3 phase 4 wire system, 3 represents a 3 phase 3 wire system and 2 represents a single phase system.

Parameter No	Modbus Start Address		Parameter
	High Byte	Low Byte	
1	00	00	Demand Time
2	00	02	Demand Period
3	00	04	Demand Interval
4	00	06	System Volts
5	00	08	System Current
6	00	0A	System Type
7	00	0C	Relay Pulse Width
8	00	0E	Energy Reset
12	00	16	Pulse Width Divisor

Important Note: Energy counters

The front panel display has an 8-digit capability for 'kilowatt-hour' and 'kVAR-hour' values, and this count will automatically roll-over to zero once the 8-digit value exceeds 99,999,999. The associated Modbus registers are scaled in 'Watt-hour' and 'VAR-hour' and will automatically roll-over to zero once a numerical value of 4,294,967,296 has been accumulated. The Modbus and display values are in-step until the energy count exceeds 4,294,967 kwh, after which the Modbus count starts again from zero, but the display count continues to increment. The display and Modbus counters can be re-synchronised by resetting the energy counters to zero, easily done through the Integra front panel or via Modbus by writing to a holding register.

Output Connection Diagram

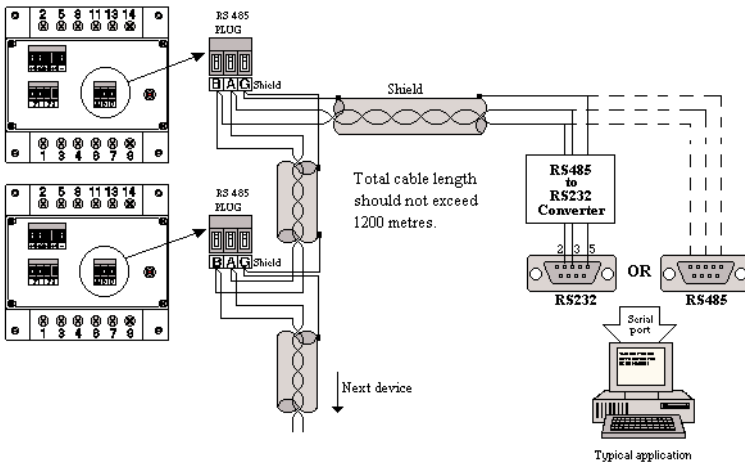

Notes

Line Topology

Each end of the cable should be terminated with a resistor. A typical value is 600Ω. Consult the cable manufacturers data or the system interrogator for the exact value. Depending on the cable used and the length of the cable run may not require any termination loading. The impedance of the termination load should match the impedance of the cable being used and should be at both ends of the line. The load should be made up of a resistor and a capacitor in series across the 'A' and 'B' terminals.

Loop Line Topology

A loop ring topology may be used if preferred. In this case no termination resistors are required.

Full Duplex/Half Duplex

Integra is half duplex (2 wire) i.e. transmits and receives on the same pair of wires. If the master has 4 connections (2 receive and 2 transmit i.e. full duplex) then common + (A)'s together and also common both -(B)'s. However make sure PLC is RS485 (4 wire) and not RS422. Also check data synchronisation i.e. half or full duplex. The PLC must be operating at the same baud rate as Integra and also half duplex.

Option 2 - RS485 Implementation for Johnson Controls Metasys

These notes explain Metasys and Crompton Instruments INTEGRA 1000 integration. Use these notes with the Metasys Technical Manual, which provides information on installing and commissioning Metasys N2 Vendor devices.

Application details

The INTEGRA 2000 is a N2 Vendor device which connects directly with the Metasys N2 Bus.

Each Metasys N2 Bus port can connect up to 70 units. Each Crompton device can be accessed by the full complement of Metasys Facility Management System (FMS) features, including Change-of-state (COS) monitoring, alarm notification, scheduling, trend and totalisation.

Components requirements

- INTEGRA 1000 with RS485 card and Metasys protocol activated.
- N2 Bus cable.

Metasys release requirements

- Metasys OWS software release 7.0 or higher.
- Metasys NCM311. NCM360.

Support for Metasys Integration from:

Johnson Control Systems
System House, Randalls Research Park,
Randalls Way, Leatherhead,
Surrey, KT22 7TS
England

Support for Crompton INTEGRA operation

See back cover for local sales and service centre.

Design considerations

When integrating the Crompton equipment into a Metasys Network, keep the following considerations in mind.

- Make sure all Crompton equipment is set up, started and running properly before attempting to integrate with the Metasys Network.
- A maximum of 70 devices can be connected to any one NCM N2 Bus.

Vendor Address 1-255 (as N2 Bus)

Port Set-up

Baud Rate	9600
Duplex	Full
Word Length	8
Stop Bits	1
Parity	None
Interface	RS485



NPT	NPA	Description	Units
ADF	1	V1	Volts
ADF	2	V2	Volts
ADF	3	V3	Volts
ADF	4	I1	Amps
ADF	5	I2	Amps
ADF	6	I3	Amps
ADF	7	Watts Line 1	KWatts
ADF	8	Watts Line 2	KWatts
ADF	9	Watts Line 3	KWatts
ADF	10	VA Line 1	KVA
ADF	11	VA Line 2	KVA
ADF	12	VA Line 3	KVA
ADF	13	VAR Line 1	KVAr
ADF	14	VAR Line 2	KVAr
ADF	15	VAR Line 3	KVAr
ADF	16	PF Line 1	
ADF	17	PF Line 2	
ADF	18	PF Line 3	
ADF	19	Phase Angle Line 1	°
ADF	20	Phase Angle Line 2	°
ADF	21	Phase Angle Line 3	°
ADF	22	System V Average	Volts
ADF	23	System I Sum	Amps
ADF	24	System W Sum	KW
ADF	25	System VA Sum	KVA
ADF	26	System VAR Sum	KVAr
ADF	27	System PF Average	
ADF	28	System Phase Angle Average	°
ADF	29	System Frequency	Hz
ADF	30	Import Watt Hour Register	KWhr
ADF	31	Export Watt Hour Register	KWhr
ADF	32	System Import VAR Hour Register	KVArhr
ADF	33	System Export VAR Hour Register	KVArhr
ADF	34	System VA Hour Register	KVAhr
ADF	35	System A Hour Register	Ahr
ADF	36	Demand (Import W)	KW
ADF	37	MAX Demand (Import W)	KW
ADF	38	Demand (Export W)	KW
ADF	39	MAX Demand (Export W)	KW
ADF	40	Demand (Import VAR)	KVAr
ADF	41	MAX Demand (Import VAR)	KVAr
ADF	42	Demand (Export VAR)	KVAr
ADF	43	MAX Demand (Export VAR)	KVAr
ADF	44	Demand (VA)	KVA
ADF	45	MAX Demand (VA)	KVA
ADF	46	Demand (I)	Amps
ADF	47	MAX Demand (I)	Amps
ADF	48	V1 Max	Volts
ADF	49	V1 Min	Volts
ADF	50	V2 Max	Volts

NPT	NPA	Description	Units
ADF	51	V2 Min	Volts
ADF	52	V3 Max	Volts
ADF	53	V3 Min	Volts
ADF	54	I1 Max	Amps
ADF	55	I1 Min	Amps
ADF	56	I2 Max	Amps
ADF	57	I2 Min	Amps
ADF	58	I3 Max	Amps
ADF	59	I3 Min	Amps
ADF	60	System V Average Max	Volts
ADF	61	System V Average Min	Volts
ADF	62	System I Max	Amps
ADF	63	System I Min	Amps
ADF	64	W1 Max	KWatts
ADF	65	W1 Min	KWatts
ADF	66	W2 Max	KWatts
ADF	67	W2 Min	KWatts
ADF	68	W3 Max	KWatts
ADF	69	W3 Min	KWatts
ADF	70	System W Max	KWatts
ADF	71	System W Min	KWatts
ADF	72	VAR 1 Max	KVAr
ADF	73	VAR 1 Min	KVAr
ADF	74	VAR 2 Max	KVAr
ADF	75	VAR 2 Min	KVAr
ADF	76	VAR 3 Max	KVAr
ADF	77	VAR 3 Min	KVAr
ADF	78	System VAR Max	KVAr
ADF	79	System VAR Min	KVAr
ADF	80	VA 1 Max	KVA
ADF	81	VA 1 Min	KVA
ADF	82	VA 2 Max	KVA
ADF	83	VA 2 Min	KVA
ADF	84	VA 3 Max	KVA
ADF	85	VA 3 Min	KVA
ADF	86	System VA Max	KVA
ADF	87	System VA Min	KVA
ADF	88	Hz Max	Hz
ADF	89	Hz Min	Hz
ADF	90	VL1L2	Volts
ADF	91	VL2L3	Volts
ADF	92	VL3L1	Volts
ADF	93	System VLL Average	Volts
ADF	94	VL1L2 Max	Volts
ADF	95	VL1L2 Min	Volts
ADF	96	VL2L3 Max	Volts
ADF	97	VL2L3 Min	Volts
ADF	98	VL3L1 Max	Volts
ADF	99	VL3L1 Min	Volts
ADF	100	System VLL Average Max	Volts
ADF	101	System VLL Average Min	Volts

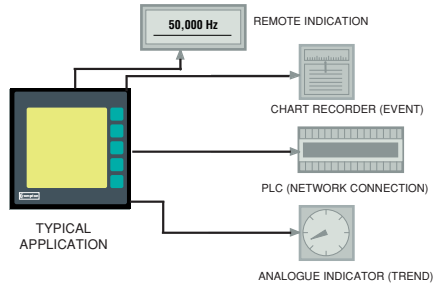

Option 3 - Analogue Outputs

This module provides four d.c. isolated outputs.

The 4-20mA output module must be powered from an external 24V d.c. source.

- Pin 16a = 0V
- Pin 16b = +24V

The output signals are presented on pins 15a to 15d.

See the output connection details for further clarification.

These outputs can be individually assigned to represent any one of the measured and displayed parameters.

All settings are user configurable via the user interface screens. See the customisation section for details.

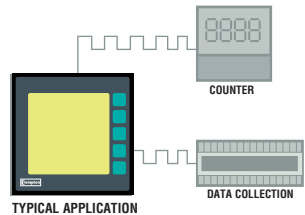

Option 4 - Pulsed Outputs

These modules supply pulses proportional to measured power.

INTEGRA 2000 can be configured via options to two pulsed outputs. Outputs are relays which are fully isolated, volt free contacts.

Both relays are user definable to any of the hours related energy parameters e.g. Wh, VARh, VAh and Ah.

The pulse width and rate are both user definable via the user interface screens.

See the customisation section for details.

Connection is made via a port screw clamp connector capable at accepting 2.5mm² cable.

Output Connection Details

Analogue Outputs - 4-20mA

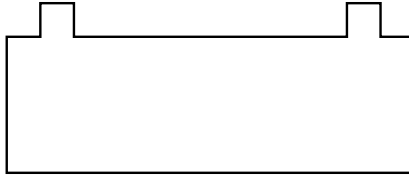

16 a	15 a	15 b	15 c	15 d	16 b
0V	OP1	OP2	OP3	OP4	24V
-	+1	+2	+3	+4	+24V

Relay

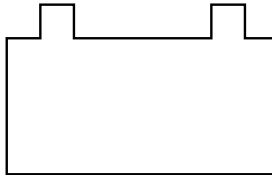

21	24	25	28
Com	N/O	Com	N/O
RLA2		RLA1	

RS485

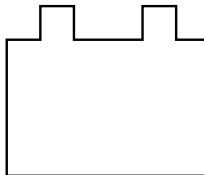

31	32	33
B	A	Gnd

Appendix A

Maximum Demand Calculation

The maximum power consumption of an installation is an important measurement as most power utilities base their charges on it. Many utilities use a thermal maximum demand indicator (MDI) to measure this peak power consumption. An MDI averages the power consumed over a number of minutes, such that short surges do not give an artificially high reading.

Integra 2000 uses a sliding window algorithm to simulate the characteristics of a thermal MDI instrument. As many different time constants are in use by the different power utilities, Integra 2000 can be configured to conform to any desired demand response.

The demand period is made up of a number of sub-intervals. Each sub-interval can be between 1 and 30 minutes duration. There can be between 1 and 30 sub-intervals in one demand period.

For example, a 15 minute demand period may be represented as 1x15 minutes,

3 x 5 minutes or 5 x 3 minutes. For each of these cases, the demand value will be updated every 15, 5 or 3 minutes respectively.

When the demand period is reset, the values in the Demand and Maximum Demand registers are set to zero. The Demand screen will show "TIMING" during the first demand period, as the values are misleading until the sliding window has been filled with valid readings. The display shows how many sub-intervals have been selected, and how many have elapsed. Once valid readings are being shown, the display counts through each sub-interval in Seconds.

The length of each sub-interval and the number of them may be altered via the RS485 port using the MODBUS protocol. The demand period can also be reset, which allows synchronisation to other equipment.

Neutral Current Calculation

The neutral current value is calculated from the sum of the three vector currents and is provided as an indication of the neutral current load and has a worst case accuracy tolerance of $\pm 4\%$ of end scale.

Appendix B

Product Specification

INPUTS

Voltage	V maximum. Measuring Range 10 - 100% Range of use 5 - 120%
Current	5 amps (1A optional). Measuring Range 10 - 100% Range of use 5 - 120%
Frequency	45 to 66Hz
Power Factor	Range of use -1 / 0 / 1 / 0 / -1
Overloads	Voltage 2x overload, applied 10 times for 1 second at 10 second intervals. Max terminal voltage 600V Current 20x overload, applied 5 times for 1 second at 5 minute intervals. Max continuous terminal current 6A
Burden	Voltage Each phase 0.02VA Current Each phase 0.6VA

OUTPUTS

Digital	Ports 1 off -	RS485 Protocol Style	Modbus® RTU 3 way 2 part screw clamp
Analogue	4 off -	Linear Style -	4-20mA dc into 0-500Ω Uni-directional Externally powered. 24V d.c. (16V -27V) 6 way 2 part screw clamp
Pulsed	Type	Relay Switching. Style	SPNO 100V dc 0.5A. 2 part screw clamp.

ISOLATION

Input to Digital O/P. Fibre	= Infinite.
RS485	= 2.2kV.
Input to Analogue O/P.	= 2.2kV
Input to Pulsed O/P.	= 2.2kV
Digital O/P to Analogue O/P	= Not Isolated.

MAXIMUM OPERATING VOLTAGE (W.R.T. GROUND)

Voltage inputs:	346V
Current inputs:	24V
Digital / Analogue outputs:	100V
Pulsed outputs:	100V

ACCURACY CLASS

Voltage	0.5% of reading ±4 Digits
Current	0.5% of reading ±4 Digits
Power	1.0% of reading ±4 Digits
Frequency	0.1% of mid freq. ±2 Digits
Phase Angle/ Power Factor	1.0% of reading ±4 Digits

Note: The accuracy of calculated line-line voltages in 4 wire units is dependant upon the phase angle between the voltages.

Display update	1 per second. 80mS approx.
Analogue O/P	1.5% of ES.
Analogue update	1 per second.
RS485 O/P	As accuracies above.
RS232 O/P	As accuracies above.
RS232 O/P	Update 50ms Average, 200mS Maximum

CLIMATIC

Temperature:	operating	0 / 50°C
	storage	-20 /+65°C
	calibration	23°C
Temperature Coefficient:		±0.013%/°C
Humidity:		95% RH non condensing
Enclosure Code:		IP54

AUXILIARY SUPPLY

100 - 250 V AC/DC	
12 - 48 V DC (option)	
Burden	6VA
Analogue output supply:	24V d.c. (16-27V), clean (transients limited to 20V peak) cable to be screened.



STANDARDS AND APPROVALS

Complies with the relevant parts of the following standards.

Consult factory for approvals listing.

Safety	IEC 1010/BSEN 61010-1, UL1244, CSA 22-2 (General electrical and mechanical safety requirement) IEC 664, VDE 0110, PD 6499 (insulation on low voltage systems)
Enclosure	EN60529, IEC 529, BS5490, (IP ratings & Fixings) DIN 43700 (Housing)
EMC	Emmissions BS EN 50081/1 Immunity BS EN 50082/2
Test	Measuring circuit BSEN 60688, IEC 688
Method	Performance BS4889, IEC 359 BSEN 61036, IEC 1036 (kWh functionality)

Notes

The Information contained in these installation instructions is for use only by installers trained to make electrical power installations and is intended to describe the correct method of installation for this product. However, Tyco Electronics has no control over the field conditions which influence product installation.

It is the user's responsibility to determine the suitability of the installation method in the user's field conditions. Tyco Electronics' only obligations are those in Tyco Electronics' standard Conditions of Sale for this product and in no case will Tyco Electronics be liable for any other incidental, indirect or consequential damages arising from the use or misuse of the products. Crompton is a trade mark.



Tyco Electronics UK Limited
Crompton Instruments

Freebournes Road, Witham, Essex, CM8 3AH, UK
Tel: +44 1376 509 509 Fax: +44 1376 509 511

<http://energy.tycoelectronics.com>